

► C66CS/C88CS
User Manual

Thank you for purchasing this product.

For optimum performance and safety, please read these instructions carefully before connecting, operating or adjusting this product. Please keep this manual for future reference.



Surge Protection Device Recommended

This product contains sensitive electrical components that may be damaged by electrical spikes, surges, electric shock, lightning strikes, etc. Use of surge protection systems is highly recommended in order to protect and extend the life of your equipment.

Contents

Introduction03

Features03

Front Panel Description04

Rear Panel Description.....04

CEC Control04

EDID Management & Smart Scaling Functionality05

Front Panel Control.....06

Infrared (IR) Control06

Terminating CAT Cables for use with HDBT.....07

Understanding the HDBaseT™ Status LED’s07

Web GUI Control08-15

Remote Control Description16

IR Commands16-17

Specifications18

Package Contents18

Maintenance18

RS-232 Config & Telnet Commands.....19-21

Web-GUI Firmware Update22-23

Main (MCU) Firmware Update24-25

Certifications26

Schematic (C88CS)27

Notes28-29

Introduction

Our Contractor 8x8 HDBaseT™ CSC Matrix offers unprecedented performance and value for the custom installation market. The C66CS and C88CS are 4K 60Hz 4:4:4 HDCP 2.2 Matrix units delivering HDMI, bi-directional IR and PoC up to lengths of 70m (at 1080p) over a single CAT cable.

These Matrix products also provide advanced features including simultaneous HDBaseT™ / HDMI on output 1 and a web browser interface module for control and configuration of the unit.

FEATURES:

- Advanced HDBaseT™ technology offering uncompressed video and audio with zero latency
- Advanced Colour Space Conversion (CSC) supports HDMI 2.0 18Gbps specification including HDR*
- Features 6 x (C66CS) or 8 x (C88CS) HDMI inputs which can be independently routed to 6 x (C66CS) or 8 x (C88CS) HDBaseT™ outputs
- Output 1 features simultaneous HDMI and HDBaseT™ output
- Video down-conversion on HDBaseT™ outputs allowing a display only capable of supporting lower video resolutions (4K 60Hz 4:2:0 or 1080p) to receive 4K 60Hz 4:4:4 video content while still showing maximum original 4K UHD resolution on remaining video outputs
- Supports 4K 60Hz 4:4:4 UHD video up to 40m
- Extends HDMI up to a distance of 70m over single CAT cable
- Supports all industry standard video resolutions including VGA-WUXGA and 480i-4K
- Supports all known HDMI audio formats including Dolby TrueHD, Dolby Atmos, Dolby Digital Plus and DTS-HD Master Audio transmission
- Web interface module for control and configuration of the Matrix
- Supports bi-directional IR on all HDBaseT™ outputs
- Control via front panel, IR, RS-232, TCP/IP and free iOS / Android Apps
- Supports PoC (Power over Cable) to power compatible HDBaseT™ Receivers
- Supplied with Blustream IR Receivers and Emitters
- 3rd party drivers available for major control systems
- 1U Design for 19" rack mount integration - mounting kit included
- Advanced EDID management
- HDCP 2.2 compliant

** CSC feature compatible with RX70CS receivers only (sold separately). The HDMI ARC and Optical Audio Return functionality of the RX70CS HDBaseT™ Receivers is not compatible with the C66CS or C88CS Matrix products.*

Front Panel Description

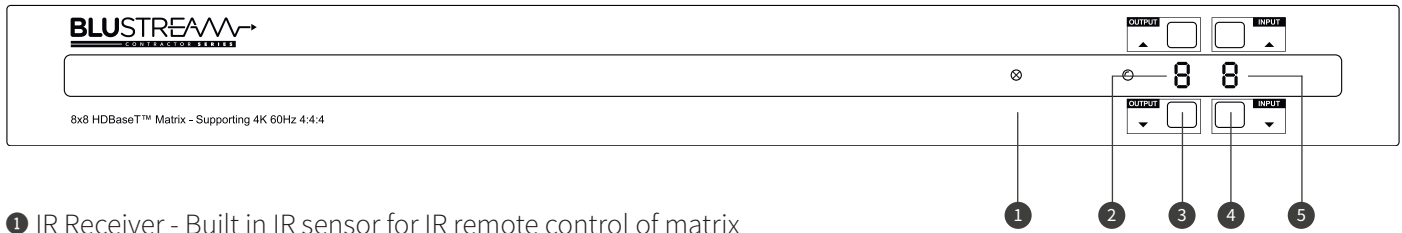

- ❶ IR Receiver - Built in IR sensor for IR remote control of matrix
- ❷ Output LCD - Shows the currently selected output
- ❸ Output Up / Down Button - Press to adjust the selected output up or down
- ❹ Input Up / Down Button - Press to adjust the selected input up or down
- ❺ Input LCD - Shows the currently selected input

Rear Panel Description

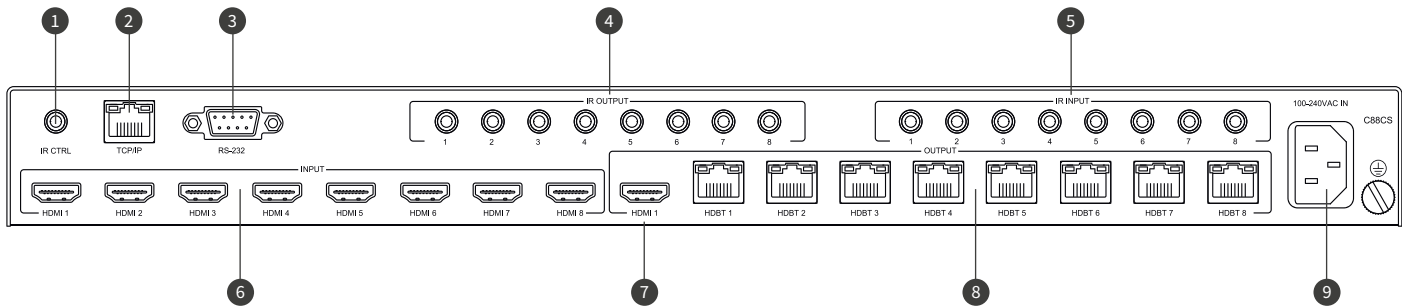

- ❶ IR Control Input - 3.5mm stereo connector to connect to Blustream IR receiver for IR control of the matrix
- ❷ TCP/IP - RJ45 connector for TCP/IP and Web GUI control of the matrix
- ❸ RS-232 - DB9 connector for RS-232 control of the matrix, and RS-232 pass-through
- ❹ IR Emitter Outputs - 3.5mm mono connector to connect to Blustream IR emitter. Used for local source control
- ❺ IR Receiver Inputs - 3.5mm stereo connector to connect to Blustream IR receiver. Used to extend IR from matrix to HDBaseT™ outputs 1-8
- ❻ HDMI Inputs - Connect to source devices
- ❼ HDMI Output - Connect to display device or AVR
- ❽ HDBaseT™ Outputs - RJ45 HDBaseT™ port to connect to the HDBaseT™ input port of the RX70CS Blustream HDBaseT™ receiver
- ❾ IEC Power Socket - Use supplied IEC power cable

CEC Control

The Matrix features CEC control of source devices and displays via the products web GUI and RS-232. It is possible to send CEC commands such as power on / off, input selection as well as volume volume up or down.

Please see the RS-232 command list at the end of this document for a full list of CEC commands available.

Please Note: CEC is subject to the support of the sources, and displays connected to the Matrix.

EDID Management

EDID (Extended Display Identification Data) is a data structure that is used between a display and a source. This data is used by the source to find out what audio and video resolutions are supported by the display. By pre-determining the video resolution and audio format of the source and display device you can reduce the time needed for EDID hand shaking thus making switching quicker and more reliable.

Configuration of the EDID settings for each input can be achieved using the following RS-232 commands to specify the required EDID:

EDIDxxDFzz

Where xx = Input: 00 refers to ALL inputs; 01-08 = specific input

zz = EDID as shown below

- | | |
|----------------------------------------------------|---------------------------------------------------|
| zz = 00 : HDMI 1080p@60Hz, Audio 2ch PCM (default) | 11 : HDMI 4K@60Hz 4:2:0, Audio 7.1ch DTS/DOLBY/HD |
| 01 : HDMI 1080p@60Hz, Audio 5.1ch DTS/DOLBY | 12 : HDMI 4K@60Hz 4:4:4, Audio 2ch PCM |
| 02 : HDMI 1080p@60Hz, Audio 7.1ch DTS/DOLBY/HD | 13 : HDMI 4K@60Hz 4:4:4, Audio 5.1ch DTS/DOLBY |
| 03 : HDMI 1080i@60Hz, Audio 2ch PCM | 14 : HDMI 4K@60Hz 4:4:4, Audio 7.1ch DTS/DOLBY/HD |
| 04 : HDMI 1080i@60Hz, Audio 5.1ch DTS/DOLBY | 15 : DVI 1280x1024@60Hz, Audio None |
| 05 : HDMI 1080i@60Hz, Audio 7.1ch DTS/DOLBY/HD | 16 : DVI 1920x1080@60Hz, Audio None |
| 06 : HDMI 1080p@60Hz/3D, Audio 2ch PCM | 17 : DVI 1920x1200@60Hz, Audio None |
| 07 : HDMI 1080p@60Hz/3D, Audio 5.1ch DTS/DOLBY | 18 : HDMI 1920x1200@60Hz, Audio 2ch PCM/6ch PCM |
| 08 : HDMI 1080p@60Hz/3D, Audio 7.1ch DTS/DOLBY/HD | 19 : User EDID 1 |
| 09 : HDMI 4K@60Hz 4:2:0, Audio 2ch PCM | 20 : User EDID 2 |
| 10 : HDMI 4K@60Hz 4:2:0, Audio 5.1ch DTS/DOLBY | |

Automatic Smart Scaling Functionality in CSC

Blustream HDBaseT™ CSC (Colour Space Conversion) outputs have an in-built automatic smart scaling feature allowing for a 4K video signal to be independently downscaled per individual HDBaseT™ output connection. The Matrix will read the EDID of the display attached to the RX70CS HDBaseT™ receiver output, downscaling the video resolution automatically where the display cannot accept the native resolution being sent from the source device. CSC will auto-downscale either video resolution, chroma sampling, or colour bit depth, it is not able to amend frame rate, or HDR elements within a signal.

The simultaneous HDMI output (output 1) will continue to pass the native signal.

Smart Scaling Conversion Table	
Native Source Signal	Smart Scaled Output Capability
4K xHz 4:4:4	4K xHz 4:2:0 (or) 1080p xHz 4:4:4
4K xHz 4:2:2	4K xHz 4:2:0 (or) 1080p xHz 4:4:4
4K xHz 4:2:0	1080p xHz 4:4:4

x = frame rate, will be equal from native to converted/scaled

Please Note: smart scaling is automatic based on the EDID of the display and cannot be controlled or adjusted by the user / integrator. To obtain resolutions lower than 1080p, a separate scaler device must be specified.

To obtain CSC pass-through the Blustream C66CS / C88CS Matrix must be used with Blustream RX70CS HDBaseT™ Receivers. Using an alternative Blustream HDBaseT™ receiver will result in the CSC functionality not being available so the maximum output resolution will be 4K 60Hz 4:2:0 (10.2Gbps).

Front Panel Control

The front panel buttons are used to individually amend the input / output structure of the Matrix. Using the Output Up / Down buttons, first select the desired output, then using the Input Up / Down buttons, select the source device to switch to. Clicking the Input Up / Down buttons scrolls through the Input / Output numbers sequentially from 1 - 6 (or) 8 then back to 1. The Output Up / Down buttons scroll from 1 - 6 (or) 8 then 'A' for All, before returning to output 1. Selecting 'A' will switch all outputs to the selected Input.

The front panel buttons can be used for other control features:

- Input Up - press and hold for 3 seconds to power off the matrix (press to power on when in standby mode)
- Output Down - press and hold for 10 seconds to turn on/off front panel button lock
- Output Up - press and hold for 3 seconds to set PTP mode (output 1 = input 1, output 2 = input 2 etc.)

Infrared (IR) Control

The Blustream range of products include Matrix control via IR.

IMPORTANT: Blustream Infrared products are all 5V and NOT compatible with alternative manufacturers Infrared solutions. When using third party 12V IR control solutions please use the Blustream IRCAB cable for IR conversion.

IR Emitter - IRE1

Blustream 5V IR emitter designed for discrete IR control of hardware.

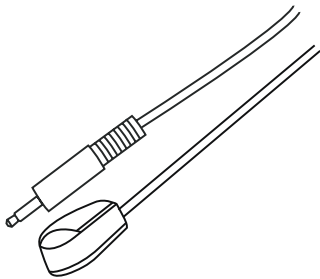

Infrared 3.5mm Pin-Out

IR Emitter - Mono 3.5mm

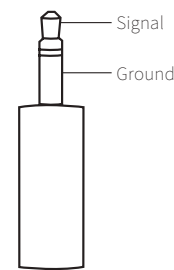

IR Receiver - IRR

Blustream 5V IR receiver to receive IR signal and distribute through Blustream products.

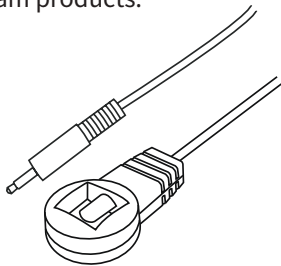

IR Receiver - Stereo 3.5mm

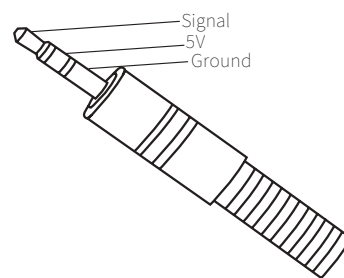

IR Control Cable - IRCAB

Blustream IR control cable 3.5mm stereo to 3.5mm mono for linking 12V third party control solutions to Blustream 5V products via IR.

Please Note: cable is directional as indicated.

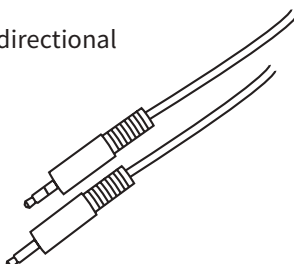

Please Note: Blustream IR hardware do not include flashing diodes to indicate IR signals being emitted or received.

Terminating CAT Cable for use with HDBaseT™

It is important that the interconnecting CAT cable between Blustream HDBaseT™ products is terminated using the correct RJ45 pin configuration. The link CAT cable MUST be a 'straight' (pin-to-pin) CAT cable, and it is advised that this is wired to the T568B wiring standard as this format is less prone to EMI (Electro-Magnetic Interference).

When installing CAT cables it is advised that you use the best possible CAT cable quality. HDMI distribution products will only work if used with CAT5e standard cable or above. Blustream recommends using a CAT6 cable (or better) for installations, especially when running longer distances, in areas of high EMI, or for 4K signal distribution. It is advised that using any method of patch panel, wall plate, or join within the CAT cable is avoided as these can add degradation to the signal. Blustream also recommend using RJ45 connectors that are recommended for use with the choice of CAT cable.

RJ45 Wiring - T568B

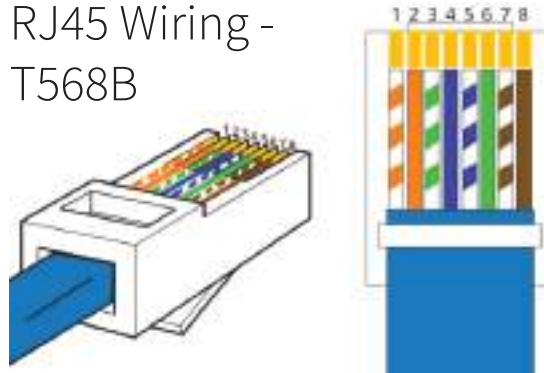

Understanding the HDBaseT™ Status LED's

The Matrix includes status LED indicators on the HDBaseT™ RJ45 ports to show all connections are active, and to help diagnose potential connectivity issues.

Understanding the Status Lights - Matrix:

- The yellow HDBaseT™ status link light will be OFF when there is no HDBaseT™ link established with a Blustream HDBaseT™ receiver
- The yellow HDBaseT™ status link light will be ON when there is a HDBaseT™ link established with a Blustream HDBaseT™ receiver
- The green HDBaseT™ link light will be OFF when there is no video signal being transmitted between the matrix and Blustream HDBaseT™ receiver
- The green HDBaseT™ link light will be ON when there is a HDCP enabled video signal being transmitted between the matrix and Blustream HDBaseT™ receiver
- The green HDBaseT™ link light will BLINK when there is a video signal with no HDCP being transmitted between the matrix and HDBaseT™ receiver

The link lights will only serve as an indication to the connectivity between Matrix and HDBaseT™ receiver unit.

The LED's will not indicate a termination, bandwidth, interference or cable length issues on a CAT cable run. Blustream always recommend qualifying / verifying / certifying a CAT cable run for suitability prior to the installation of HDBaseT™ equipment.

Web GUI Control

The following pages take you through the operation of this Matrix's Web GUI. You must connect the TCP/IP RJ45 socket to your local network in order to access the product's Web GUI.

By default the matrix is set to DHCP, however if a DHCP server (eg: network router) is not installed the matrix IP address will revert to below details:

Default IP Address is: **192.168.0.200**

Default Username is: **blustream**

Default Password is: **1234**

The Web GUI supports multiple users along with multiple user permissions as follows:

Guest Account - This account does not require a user to login. The Guest account can only change sources for each zone. Guest access can be changed / removed completely by the Admin, limiting inputs or outputs as required.

User Accounts - up to 7 User accounts (on top of 1 Guest account) can be utilised, each with individual login details. User accounts can be assigned permissions to specific areas and functions. A User must first login to make use of these functions.

Admin Account - This account allows full access to all functions of the Matrix, as well as assigning users with permissions.

Guest Control Page

The Guest Control Page allows a guest user to change inputs for each zone (output) without needing to be logged into the Matrix. Simply select the square that corresponds with the input and zone you wish to change.

There is also a power button on the lower right corner to turn the Matrix on or off.

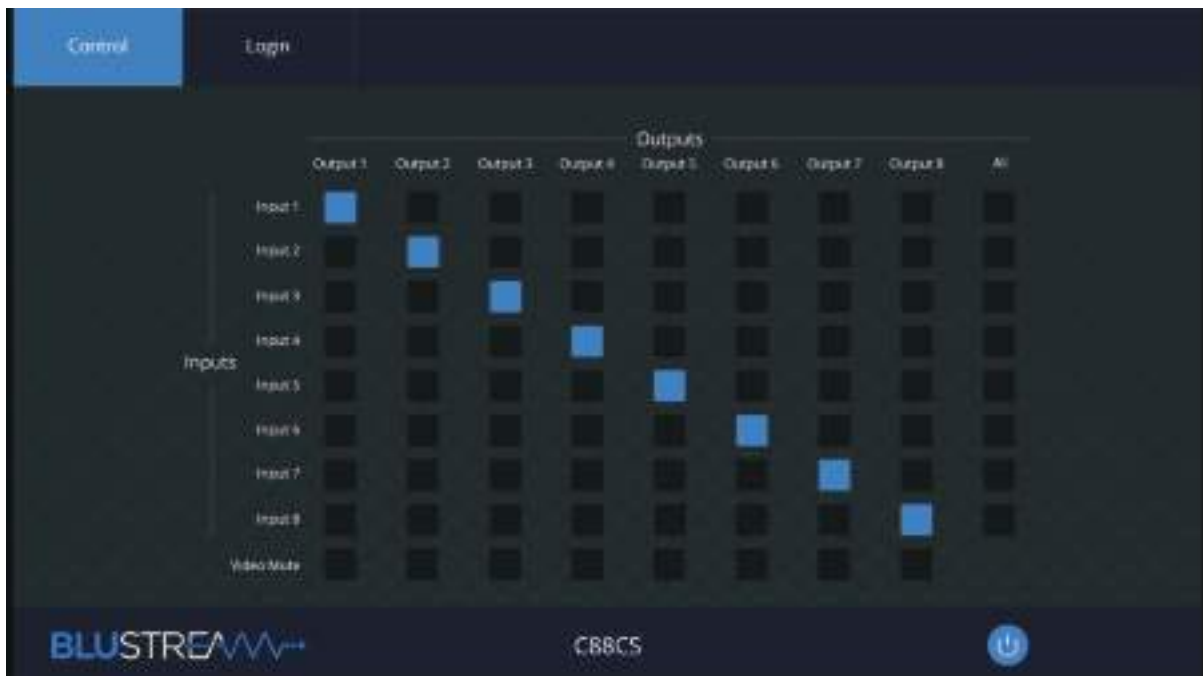

Login Page

The Login Page allows a user or admin to login and access additional functionality. This page also shows you the current firmware version of both the Matrix and Web GUI.



User Control Page

The Control Page allows a user to change inputs for each zone (output). Simply select the square that corresponds with the input and zone you wish to change.

A User or Admin also has the ability to Save or Recall pre-configured Presets. A Saved Preset will store the specified input to output configuration, and allow the configuration to be recalled as required.

There is also a power button on the lower right corner to turn the Matrix on or off.



Configuration Page - Input

The Configuration Page allows for configuration settings for both inputs and outputs of the Matrix. The configuration menu for either Input or Output is located at the top of the window.

Within the Input Page, enter a Name for each input as well as specify the required EDID from the drop down menu.



Configuration Page - Output

The Output Page allows settings specific to the outputs of the Matrix to be changed.

A Name can be specified as well as turn PoC (Power Over Cable) on or off for each output / receiver.



CEC Page - Input

The CEC Page allows for a pre-defined, or user-defined CEC command to be sent to any Input or Output connected to the Matrix.

Choose between Input, Output and User-defined sections at the top of the window.

On the CEC Input Page, you must specify a specific input to send the CEC command out of. Press the icon of the command you wish to send at it will be transmitted to the source device connected to the specified input.

Please Note: CEC is subject to the support of the sources and displays connected to the Matrix.



CEC Page - Output

On the CEC Output Page, you must specify a specific output to send the CEC command out of. Press the icon of the command you wish to send at it will be transmitted to the display device connected to the specified output.

Please Note: CEC is subject to the support of the sources and displays connected to the Matrix.



CEC Page - User-defined

On the CEC User-defined Page, you can enter custom CEC commands and have these transmitted out of either an input or output. **Please Note:** CEC is subject to the support of the sources and displays connected to the Matrix.



RS-232 Page - Local

The RS-232 page allows you to send commands either out of the local RS-232 port on the Matrix itself, or via HDBT and out of a compatible HDBT Receiver connected to a display. If the Local radio box is selected, RS-232 commands will be sent out of the DB9 serial port at the rear of the Matrix. Baud rate and terminator command as well as Hex or ASCII can be selected.



RS-232 Page - HDBT

The RS-232 HDBT Page allows you to remotely control devices connected via DB9 serial to remote HDBT Receivers independently. It is also possible to automate the display on, input select and display off process via RS-232 for each HDBT output, when the Matrix is turned on.

If RS-232 On is enabled, the Display On, Display Input Select, User Commands 1, 2, and 3 are all sent out of the corresponding HDBT Receiver, when the Matrix is turned on.

If RS-232 Off is enabled, the User Off Command will be sent out of the corresponding HDBT Receiver with a delay of 3 secs between commands, when the Matrix is turned off.

You can also specify the Baud Rate and Command Ending (eg: new line, carriage return) for the match the RS-232 device connected to the HDBT Receiver.



Network Page

The Network Page allows you to specify the TCP/IP network port settings. You can choose from Static IP or DHCP, as well as specify a fixed IP Address, Subnet Mask, and Gateway. It is also possible to change or disable the Telnet port to suit the network and communication required for control.



Upgrade Firmware Page

The Upgrade Firmware Page allows you to upgrade the MCU firmware of the Matrix via the Web GUI. Simply click Browse and select the appropriate firmware file from your computer (firmware available to download from the Blustream website). Clicking Submit will send the firmware file to the Matrix and begin the upgrade process. The upgrade process will take several minutes to complete and the Matrix will reboot once finished. Please do not disconnect your computer, or Matrix, from the network until the firmware has been delivered successfully.



Admin Page

The Admin Page allows the administrator to configure up to 8 users including a guest user. Individual users can adjust their own credentials via this page.

The Admin, or Users who have been given Admin permissions, are able to allocate permissions to Users. These permissions include allowing or disabling access to pages contained within the Web GUI, as well as allowing or disabling access to each input or output of the Matrix.

The Admin Page also allows the Front Panel buttons of the Matrix to be locked or unlocked, enable or disable the Front Panel IR window, as well as Factory Reset the Matrix to default.



Specifications

C88CS

- **Video Input Connectors:** 8 x HDMI Type A, 19-pin, female
- **Video Output Connectors:** 1 x HDMI Type A, 19-pin, female, 8 x HDBaseT™ RJ45 connectors
- **RS-232 Serial Port:** 1 x DB-9, female
- **IR Input Ports:** 9 x 3.5mm stereo jack
- **IR Output Ports:** 8 x 3.5mm mono jack
- **Rack Mountable:** 1U rack height, rack ears included
- **Casing Dimensions (W x H x D):** 437mm x 44mm x 377mm (without feet)
- **Dimensions (W x H x D):** 437mm x 53mm x 384mm (with feet and connections)
- **Shipping Weight:** 5.0kg
- **Operating Temperature:** 32°F to 104°F (-5°C to +55°C)
- **Storage Temperature:** -4°F to 140°F (-25°C to +70°C)
- **Power Supply:** Internal 100-240V AC

C66CS

- **Video Input Connectors:** 6 x HDMI Type A, 19-pin, female
- **Video Output Connectors:** 1 x HDMI Type A, 19-pin, female, 6 x HDBaseT™ RJ45 connectors
- **RS-232 Serial Port:** 1 x DB-9, female
- **IR Input Ports:** 7 x 3.5mm stereo jack
- **IR Output Ports:** 6 x 3.5mm mono jack
- **Rack Mountable:** 1U rack height, rack ears included
- **Casing Dimensions (W x H x D):** 437mm x 44mm x 377mm (without feet)
- **Dimensions (W x H x D):** 437mm x 53mm x 384mm (with feet and connections)
- **Shipping Weight:** 5.0kg
- **Operating Temperature:** 32°F to 104°F (-5°C to +55°C)
- **Storage Temperature:** -4°F to 140°F (-25°C to +70°C)
- **Power Supply:** Internal 100-240V AC

NOTE: Specifications are subject to change without notice. Weights and dimensions are approximate.

Package Contents

C88CS

- 1 x C88CS
- 1 x Rack Mounting Kit
- 1 x Remote Control
- 8 x IR Emitters
- 9 x IR Receivers
- 1 x Serial Cable - DB9 to DB9
- 1 x IR Control Cable - 3.5mm-3.5mm Cable
- 1 x Quick Reference Guide
- IEC Power Cable(s)

C66CS

- 1 x C66CS
- 1 x Rack Mounting Kit
- 1 x Remote Control
- 6 x IR Emitters
- 7 x IR Receivers
- 1 x Serial Cable - DB9 to DB9
- 1 x IR Control Cable - 3.5mm-3.5mm Cable
- 1 x Quick Reference Guide
- IEC Power Cable(s)

Maintenance

Clean this unit with a soft, dry cloth. Never use alcohol, paint thinner or benzene to clean this unit.

RS-232 Configuration and Telnet Commands

The Blustream Matrix can be controlled via serial and TCP/IP.

The RS-232 port is used for configuration and control of the product, as well as pass through of RS-232 commands to a compatible Blustream HDBaseT™ receiver.

The default RS-232 communication settings are:

Baud rate: 57600

Data bit: 8

Stop bit: 1

Parity bit: none

The following pages list all available serial commands.

Commonly Used Serial Commands:

There are several commands that are commonly used for control and testing:

STATUS	Status will give feedback on matrix such as zones on, type of connection etc...
PON	Power on
POFF	Power off
OUTxxON	(xx is the zone number you wish to turn on)
Example:	OUT01ON (This would turn output one back on)
OUTxxFRyy	(xx is the zone out, yy is the input)
Example:	OUT01FR04 (This would switch output 1 to source input 4)

Common Mistakes:

- Carriage return – Some programs do not require the carriage return where as other will not work unless sent directly after the string. In the case of some Terminal software the token <CR> is used to execute a carriage return. Depending on the program you are using this token maybe different. Some other examples that other control systems deploy include \r or 0D (in hex)
- Spaces – Blustream commands do not require space between commands unless specified. There may be some programs that require spacing in order to work.
 - How the string should look is as follows OUT01ON
 - How the string may look if spaces are required: OUT{Space}01{Space}ON
- Baud rate or other serial protocol settings not correct

RS-232 Configuration and Telnet Commands

COMMAND	ACTION
?	Print help information
HELP	Print help information
STATUS	Print system status and port status
INSTA	Print All Inputs Status
OUTSTA	Print All Outputs Status
CTRLSTA	Print All Controls Status
PRESETSTATUS	Print All Preset Configurations
PON	Power On, system run on normal state
POFF	Power Off, system run on power save state
RESET	Reset System To Default Setting
KEY ON/OFF	Set system (front panel) KEY control On or Off
NET IP xxx.xxx.xxx.xxx	Set IP Address
NET GW xxx.xxx.xxx.xxx	Set Gateway Address
NET SM xxx.xxx.xxx.xxx	Set Subnet Mask Address
NET RB	Set Network Reboot and Apply New Config
NET TN xxxx	Set Telnet Port
NET DHCP ON/OFF	Set Auto IP(DHCP) ON Or OFF
RS232BAUD z	Set RS232 Baud Rate To z z = 1 2400, 2 4800, 3 9600, 4 19200, 5 38400, 6 57600 (default), 7 115200"
RS232OUT xx ON	Enable RS232 Remote-control Mode On HDBT Output xx To Allow Matrix To Be Controlled From Remote PC

COMMAND	ACTION
RS232OUT xx OFF	Disable RS232 Remote-control Mode On HDBT Output xx To Allow Matrix To Be Controlled From Remote PC
RS232ONOUT xx y:z:a:b	When detecting a triggering signal, automatically send y type of command a stored in slot x to the third-party device whose baud rate is z On Output xx xx = 00 : All Outputs xx = [01-08] : Output 1 - 8 y = 1 Send RS232 display on y = 2 Send RS232 display input select y = 3 Send RS232 user command 1 y = 4 Send RS232 user command 2 z = a ASCII z = h HEX a = 1 2400 a = 2 4800 a = 3 9600 a = 4 19200 a = 5 38400 a = 6 57600 (default) a = 7 115200 b = RS232 command
RS232OFFOUT xx z:a:b	When a triggering signal is not detected, automatically send y type of command a to the third-party device whose baud rate is z On Output xx xx = 00 : All Outputs xx = [01-08] : Output 1 - 8 z = a ASCII z = h HEX a = 1 2400 a = 2 4800 a = 3 9600 a = 4 19200 a = 5 38400 a = 6 57600 (default) a = 7 115200 b = RS232 command
RS232ONOUT xx DISABLE	Disable Automatic RS232 Commands When Detecting Signal On Output xx xx = 00 : All Outputs xx = [01-08] : Output 1 - 8
RS232OFFOUT xx DISABLE	Disable Automatic RS232 Commands When Not Detecting Signal On Output xx xx = 00 : All Outputs xx = [01-08] : Output 1 - 8
MXIR xx FR yy	Local Matrix IR Out xx From Remote Rx yy IR In xx = [01-08] : Local IR Out 1 - 8 yy = [01-08] : Remote Rx IR In 1 - 8 yy = [00] : All Remote Rx IR In
IROUT xx ON	Enable IR Remote-control Mode On HDBT Output xx To Allow Matrix To Be Controlled From Receiver IR
IROUT xx OFF	Disable IR Remote-control Mode On HDBT Output xx To Allow Matrix To Be Controlled From Receiver IR

RS-232 Configuration and Telnet Commands

COMMAND	ACTION
EDID SAVE zz	Save External EDID Into Slot zz zz = 19 User EDID 1 zz = 20 User EDID 2
EDID xx DF zz	Change EDID For Input xx xx = Input (00 refers to ALL inputs, 02 = input 2 etc) zz = EDID as shown below 00: HDMI 1080p@60Hz, Audio 2CH PCM (default) 01: HDMI 1080p@60Hz, Audio 5.1CH DTS/DOLBY 02: HDMI 1080p@60Hz, Audio 7.1CH DTS/DOLBY/HD 03: HDMI 1080i@60Hz, Audio 2CH PCM 04: HDMI 1080i@60Hz, Audio 5.1CH DTS/DOLBY 05: HDMI 1080i@60Hz, Audio 7.1CH DTS/DOLBY/HD 06: HDMI 1080p@60Hz/3D, Audio 2CH PCM 07: HDMI 1080p@60Hz/3D, Audio 5.1CH DTS/DOLBY 08: HDMI 1080p@60Hz/3D, Audio 7.1CH DTS/DOLBY/HD 09: HDMI 4K@60Hz 4:2:0/4K@30Hz 4:4:4, Audio 2CH PCM 10: HDMI 4K@30Hz 4:2:0/4K@30Hz 4:4:4, Audio 5.1CH DTS/DOLBY 11: HDMI 4K@30Hz 4:2:0/4K@30Hz 4:4:4, Audio 7.1CH DTS/DOLBY/HD 12: HDMI 4K@60Hz 4:4:4, Audio 2CH PCM 13: HDMI 4K@60Hz 4:4:4, Audio 5.1CH DTS/DOLBY 14: HDMI 4K@60Hz 4:4:4, Audio 7.1CH DTS/DOLBY/HD 15: DVI 1280x1024@60Hz, Audio None 16: DVI 1920x1080@60Hz, Audio None 17: DVI 1920x1200@60Hz, Audio None 18: HDMI 1920x1200@60Hz, Audio 2CH PCM/6CH PCM 19: User EDID 1 20: User EDID 2
EDID xx CP yy	Copy EDID From Output yy To Input xx xx = 00 : All Inputs xx = [01-08] : Inputs 1 - 8 yy = [01-08] : Output 1 - 8
PRESET pp SAVE	"Save Current Output Connections To Preset pp Config pp = [01-09] : Preset 1 - 9"
PRESET pp SET	Set Preset pp Config
PRESET pp CLR	Delete Preset pp Config
POCOUT xx ON	Set PoC On on ouput xx
POCOUT xx OFF	Set PoC Off on ouput xx
OUT xx FR yy	Set Output xx From Input:yy xx = 00 : All Outputs xx = [01-08] : Output 1 - 8 yy = [01-08] : Input 1 - 8
OUT xx ON	Set Output xx On xx = 00 : All Outputs xx = [01-08] : Output 1 - 8
OUT xx OFF	Set Output xx Off xx = 00 : All Outputs xx = [01-08] : Output 1 - 8
OUT xx EH/ET	Set OUTPUT:xx use HDMI/HDBT EDID xx=[00]: All OUTPUT port, [01...08]: OUTPUT port yy=[01...08]: INPUT port

COMMAND	ACTION
IN xx CECOK	Confirm operation (Enter) on input xx
IN xx CECUP	Up on input xx
IN xx CECDOWN	Down on input xx
IN xx CECLEFT	Left on input xx
IN xx CECRIGHT	Right on input xx
IN xx CECRETURN	Back to submenu on input xx
IN xx CECEXIT	Exit on input xx
IN xx CECVOLUP	Volume up on input xx
IN xx CECVOLDOWN	Volume down on input xx
IN xx CECPLAY	Play on input xx
IN xx CECSTOP	Stop on input xx
IN xx CECPAUSE	Pause on input xx
IN xx CECRECORD	Record on input xx
IN xx CECREWIND	Rewind on input xx
IN xx CECFF	Fast forward on input xx
IN xx CECFWD	Forward on input xx
IN xx CECBWD	Backward on input xx
IN xx CECPOFF	Power off on input xx
IN xx CECPON	Power on on input xx
OUT xx CECVOLUP	Volume up on output xx
OUT xx CECVOLDOWN	Volume down on output xx
OUT xx CECMUTE	Mute toggle on output xx
OUT xx CECPOFF	Power off on output xx
OUT xx CECPON	Power on on output xx
OUT xx CECOK	Confirm operation (Enter) on input xx
OUT xx CECUP	Up on input xx
OUT xx CECDOWN	Down on input xx
OUT xx CECLEFT	Left on input xx
OUT xx CECRIGHT	Right on input xx
OUT xx CECRETURN	Back to submenu on input xx
OUT xx CECEXIT	Exit on input xx
OUT xx CECPLAY	Play on input xx
OUT xx CECSTOP	Stop on input xx
OUT xx CECPAUSE	Pause on input xx
OUT xx CECRECORD	Record on input xx
OUT xx CECINPUT yy	CEC Input channel yy selection on output xx xx=00: Select All Output Port xx=[01...08]: Output 1-8 yy=[01...08]: Select One HDMI In Port 1-8

Web GUI Firmware Update

The Web GUI of the C66CS/C88CS Matrix is used to configure and control the product through a web portal. The C66CS/C88CS can be accessed on any internet connected device including: tablets, smart phones and laptops that are sat on the same network as the Matrix.

As the Web GUI is used to update the main Matrix firmware, it is important to ensure that the Web GUI firmware is the latest version before updating the main Matrix firmware. Please check the reported firmware versions against the versions available to download from the Blustream website.

To update the Web GUI firmware:

1) Login to the Web GUI update menu:

Default IP Address is: **192.168.0.200:100**

Default Username is: **blustream** Default Password is: **1234**

Please Note: the IP address may differ if default network settings have been updated. If this is the case, please replace the following with the products current IP address:

XXX.XXX.XXX.XXX:100

2) Once the Web GUI menu interface has been accessed, expand the 'Administration' file in the menu tree by clicking the small '+' icon next to the file.

3) Select 'Upload Firmware':



4) Click 'Choose File' and select the Web GUI (MediaTek) firmware file downloaded from the Blustream website. This will be a .bin type file:



5) Press 'Apply' to begin the firmware update process.

The update process will take up to 1 minute to complete. Do not refresh or navigate away from this page until the update process has completed.

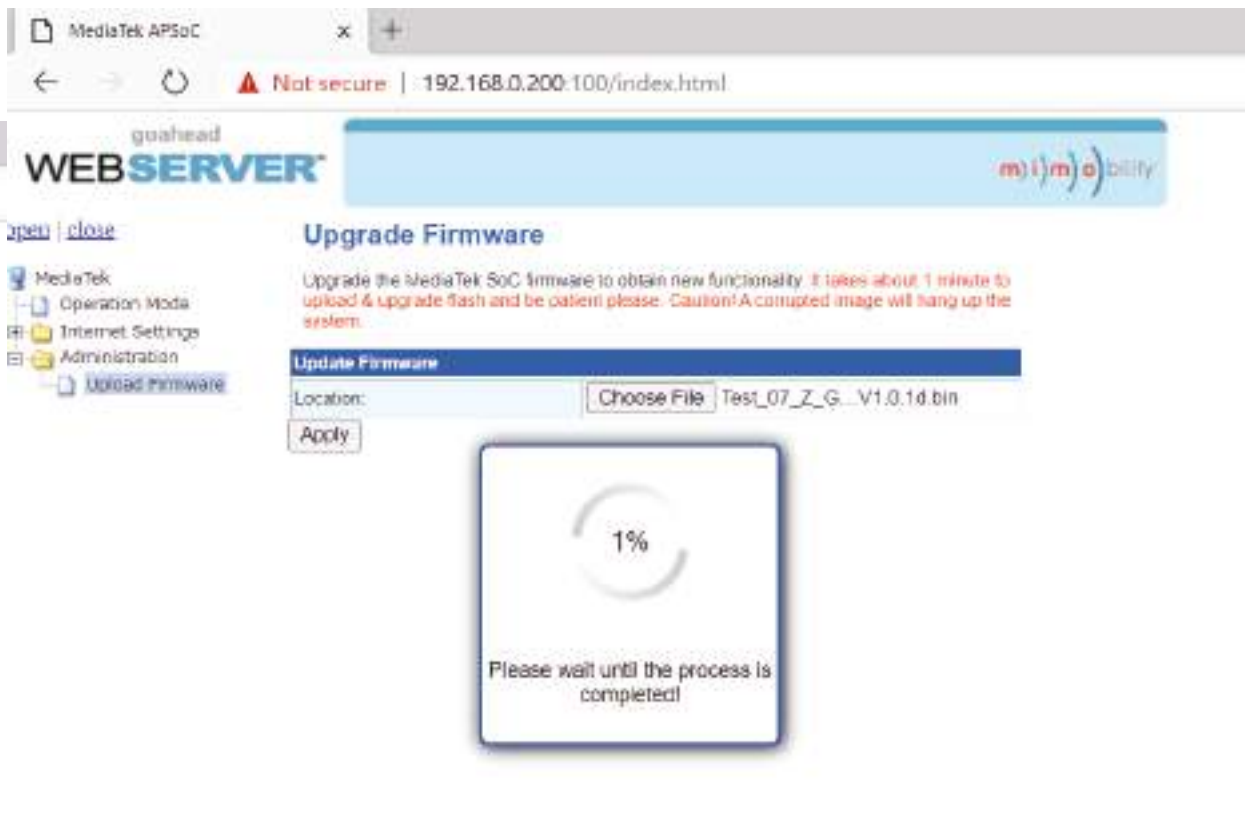

Matrix Main (MCU) Firmware Update

The Matrix main (MCU) firmware update is completed from within the Matrix Web GUI. It is important that the Web GUI firmware is applied PRIOR to updating the main MCU firmware for the Matrix.

To update the main (MCU) firmware:

1) Login to the matrix Web GUI:

Default IP Address is: **192.168.0.200**

Default Username is: **blustream** Default Password is: **1234**

Please note: as before, if the default network settings have been changed please use the custom IP address to login to the product.

2) Once the main product Web GUI has been accessed, click on the tab at the top of the page marked ‘Upgrade Firmware’:

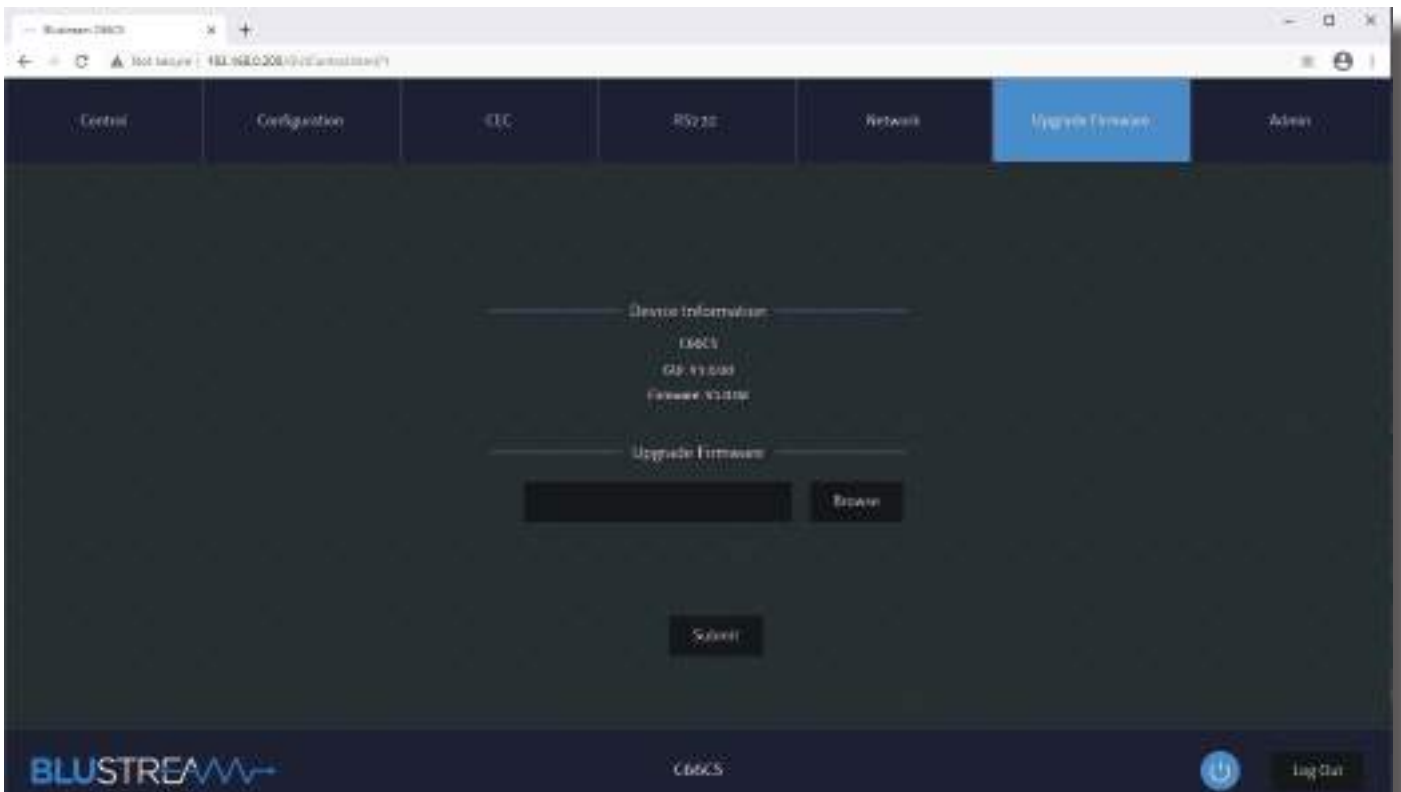

3) Select ‘Browse’

4) Press ‘Choose File’ and select the main (MCU) firmware file downloaded from the Blustream website. This will be a .app type file.

5) Press 'Submit' to begin the firmware update process:

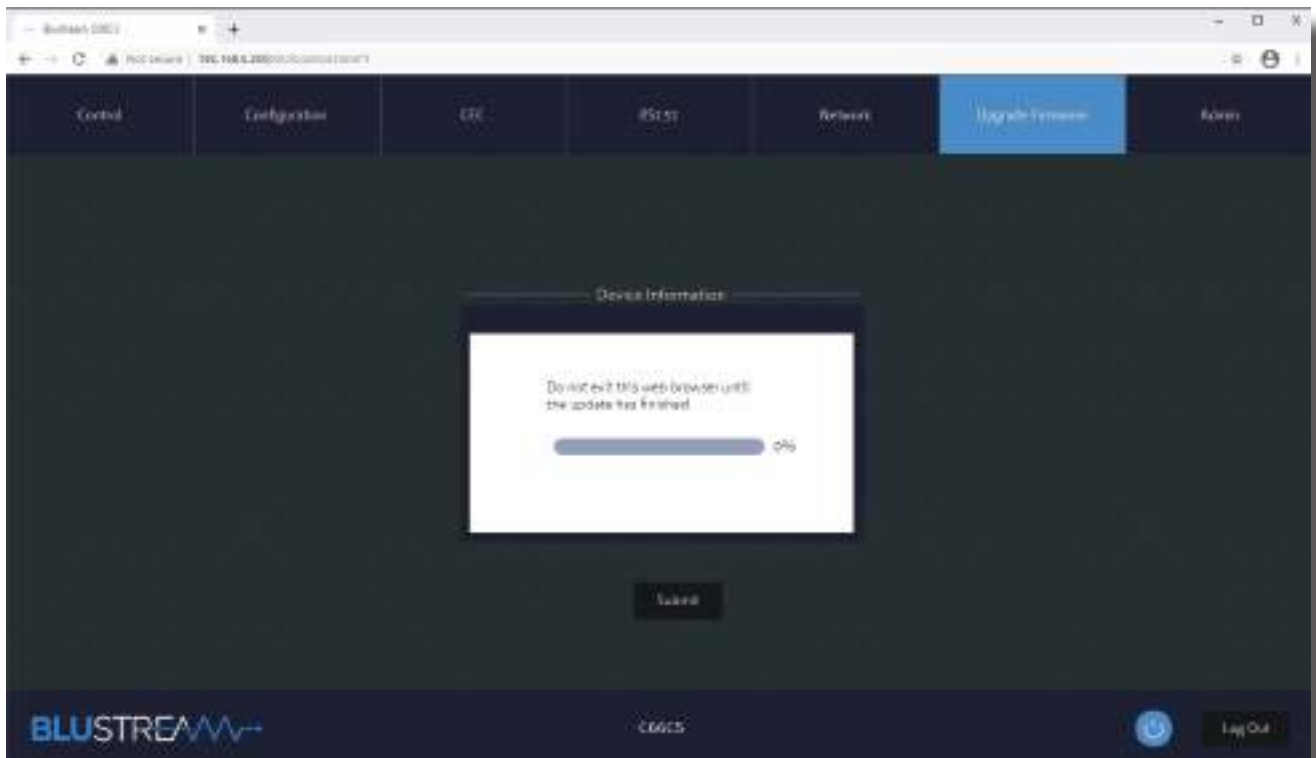

The update process will take up to 1 minute and once complete the message 'Success' will be shown. Do not refresh or navigate away from this page until the update process has completed.

6) The Matrix will reboot once the update has finished.

7) Once the Matrix has rebooted, login to the product and confirm both firmware levels have updated to the latest versions:

Please Note: you may have to refresh your browser for the updated firmware versions to show.



Certifications

FCC Notice

This equipment has been tested and found to comply with the limits for a Class B digital device, pursuant to part 15 of the FCC Rules. These limits are designed to provide reasonable protection against harmful interference in a residential installation. This equipment generates, uses, and can radiate radio frequency energy and, if not installed and used in accordance with the instructions, may cause harmful interference to radio communications. However, there is no guarantee that interference will not occur in a particular installation. If this equipment does cause harmful interference to radio or television reception, which can be determined by turning the equipment off and on, the user is encouraged to try to correct the interference by one or more of the following measures:

- Reorient or relocate the receiving antenna.
- Increase the separation between the equipment and receiver.
- Connect the equipment into an outlet on a circuit different from that to which the receiver is connected.
- Consult the dealer or an experienced radio/TV technician for help.

CAUTION - changes or modifications not expressly approved by the party responsible for compliance could void the user's authority to operate the equipment.

CANADA, INDUSTRY CANADA (IC) NOTICES

This Class B digital apparatus complies with Canadian ICES-003.

Operation is subject to the following two conditions: (1) this device may not cause interference, and (2) this device must accept any interference, including interference that may cause undesired operation of the device.

CANADA, AVIS D'INDUSTRY CANADA (IC)

Cet appareil numérique de classe B est conforme aux normes canadiennes ICES-003.

Son fonctionnement est soumis aux deux conditions suivantes : (1) cet appareil ne doit pas causer d'interférence et (2) cet appareil doit accepter toute interférence, notamment les interférences qui peuvent affecter son fonctionnement.

CORRECT DISPOSAL OF THIS PRODUCT

This marking indicates that this product should not be disposed with other household wastes. To prevent possible harm to the environment or human health from uncontrolled waste disposal, recycle it responsibly to promote the sustainable reuse of material resources. To return your used device, please use the return and collection systems or contact the retailer where the product was purchased. They can take this product for environmentally safe recycling.



Schematic

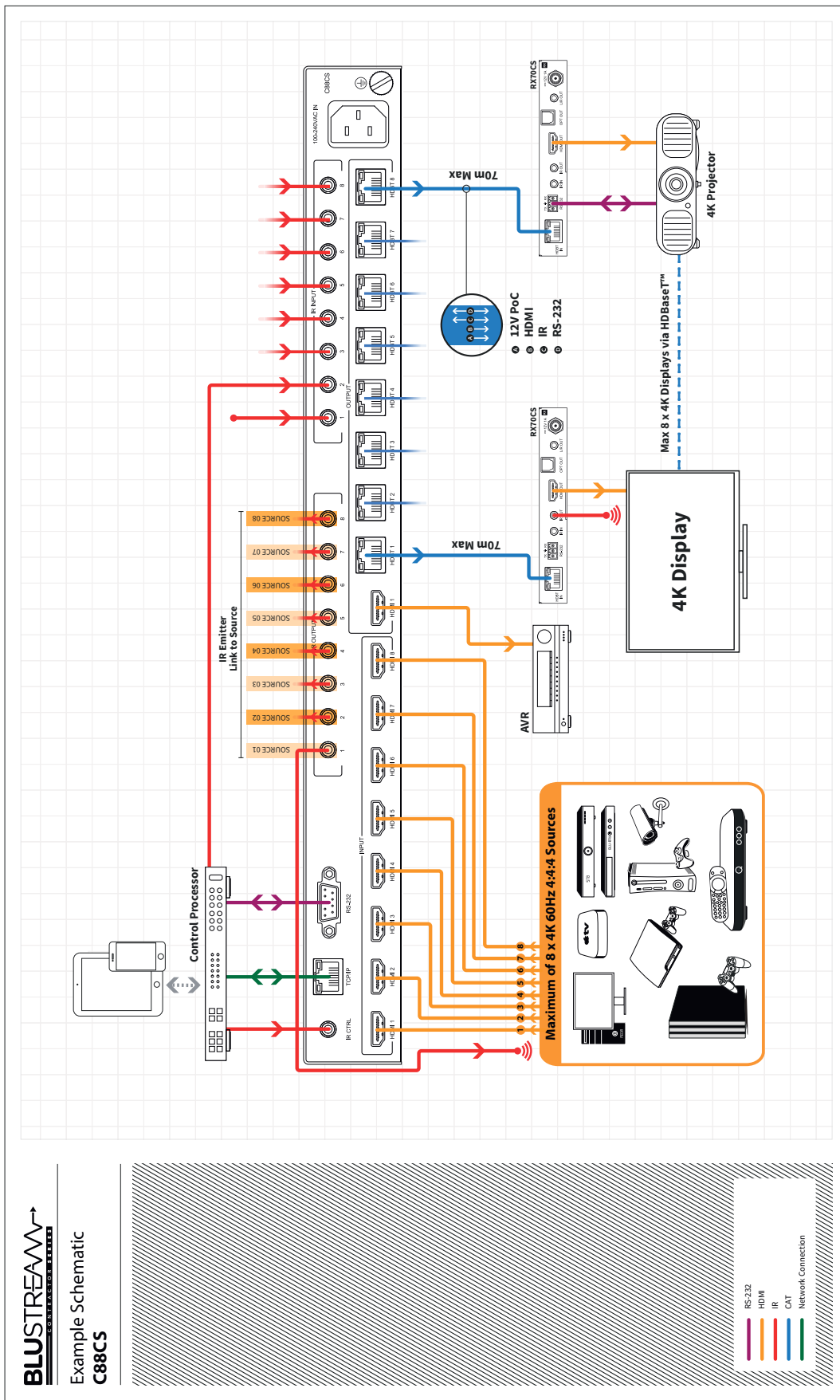

BLUSTREAM
CONTRACTOR SERIES
Example Schematic
C88CS



www.blustream.com.au
www.blustream-us.com
www.blustream.co.uk